

# Specification

## Planar Neon Series NMT1312-Plus ( DMX512 & SPI)

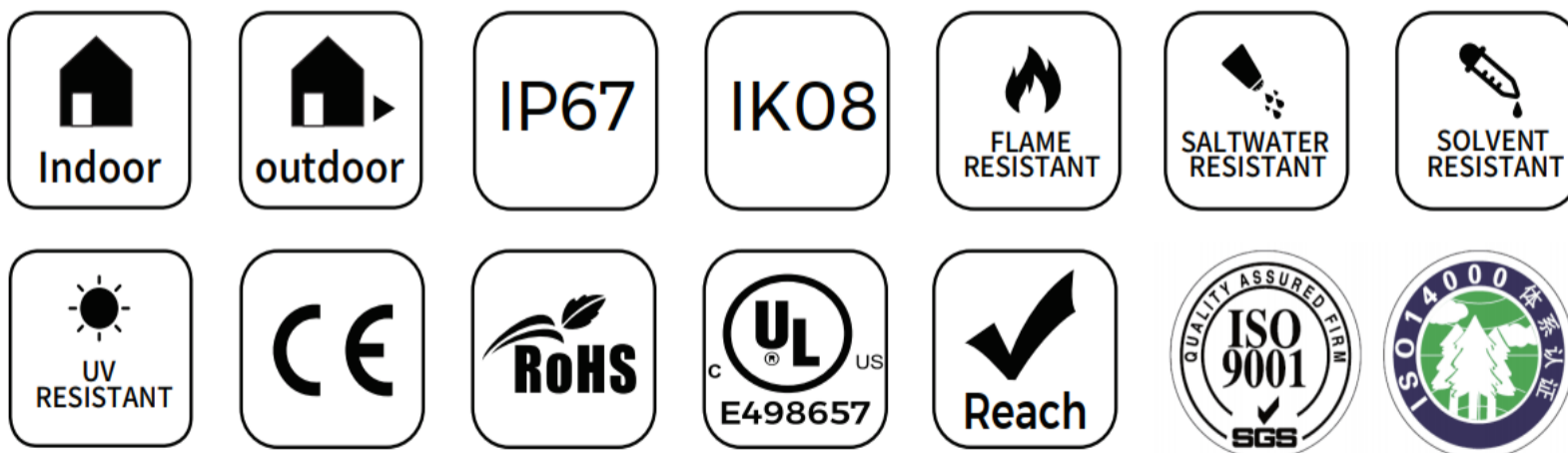

### ▼ Features



SPI/DMX512

- ※ Light source: SMD 5050LED.
- ※ Process & Material: High light transmittance, food-grade environmental silicone material, integrated extrusion molding technology, IP67.
- ※ Optical Design: Unique optical light distribution structure design, uniform lighting surface and no shadow.
- ※ Appearance Design: Compared with the traditional neon tube or PVC guardrail tube, the silicone material has good flexibility, the simple and stylish appearance, which is exquisite and unique.
- ※ Product Certification: UL、CE、ROHS.
- ※ Environmental Features: Resistance to saline solutions, acids & alkali, corrosive gases and UV.
- ※ Working/Storage Temperature: Ta:-20~40°C / 0°C ~ 60°C.
- ※ Life Span: 2 years warranty.

### ▼ Product Application

- ※ Signage Lighting
- ※ Outdoor/indoor decorative
- ※ Architectural Contour lighting

### ▼ Product Bending Application

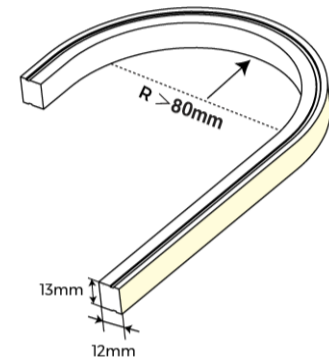

### ▼ Product's protective technology & structure size

#### full protective End-Cap

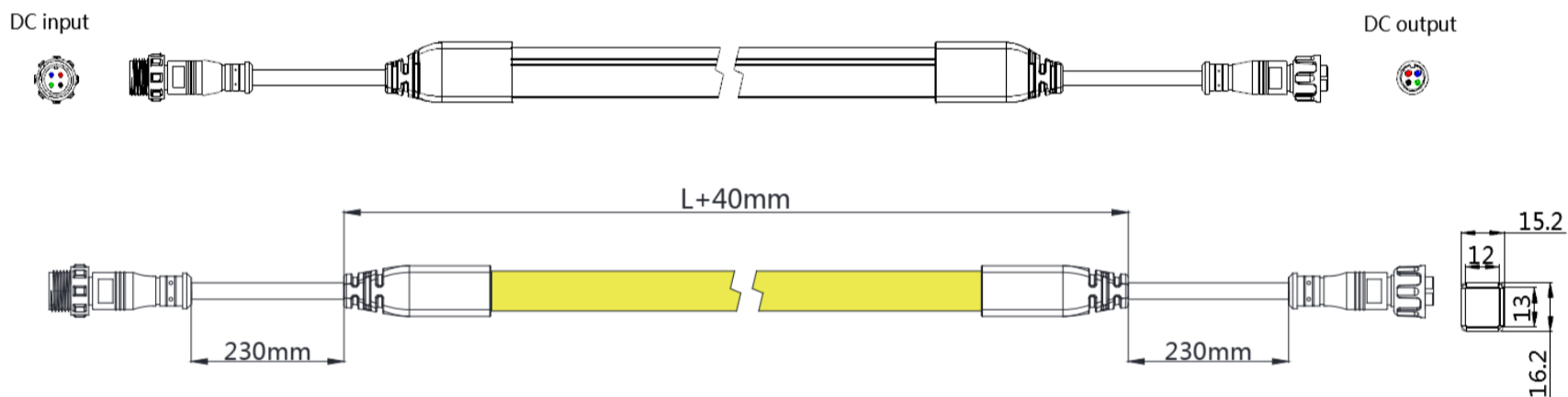

#### Shadowless End-Cap

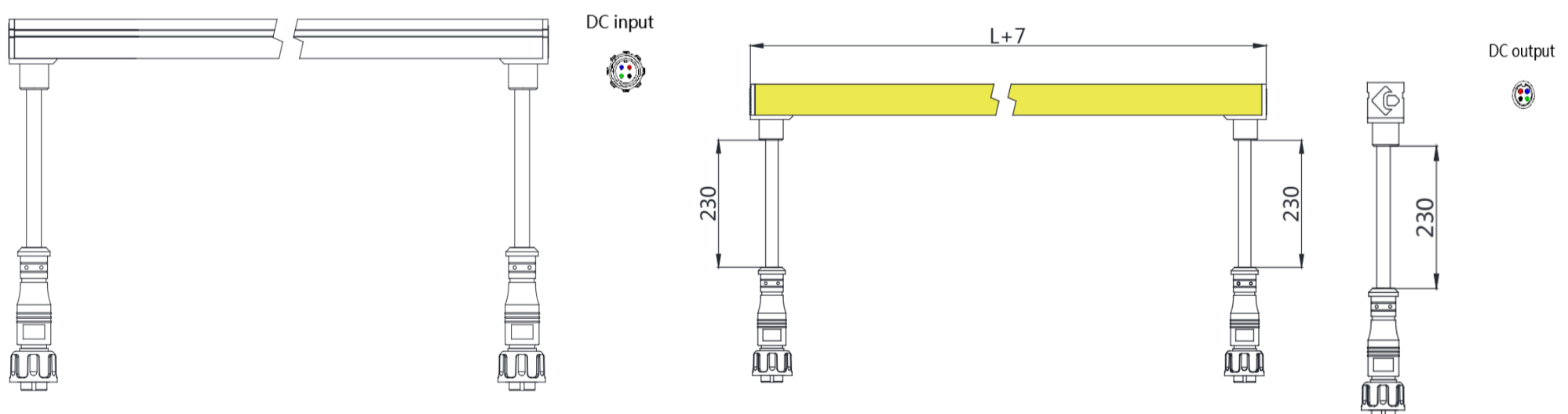

▼ **Basic Parameters**

Model	CCT/colors	CRI	Input voltage (V)	Rated current (A)	Rated power (w)	Lumens/M (LM)	Size (mm)	Max.length	Cutting unit (mm)
NMT1312-ORGBX24CDS025CC0500-Plus-EP/NP(SPI)	RGB	/	24V	0.75	18	350	W13*H12	5000mm	83.33
	R 620-630nm					100			
	G 525-530nm					220			
	B 465-470nm					45			
NMT1312-8XWX24CDS025CC0500-Plus-EP/NP(SPI)	2300K	≥70				850			
	2700K	≥80				850			
	3000K					900			
	4000K					900			
NMT1312-ORGBM24CDS025CC0500-Plus-EP/NP(DMX512)	RGB	/				350			
	R 620-630nm					100			
	G 525-530nm					220			
	B 465-470nm					45			
NMT1312-8XWM24CDS025CC0500-Plus-EP/NP(DMX512)	2300K	≥70				850			
	2700K	≥80				850			
	3000K					900			
	4000K					900			

Note :

- 1、 The above data is the testing result of 1M standard product;
- 2、 The power and lumens of output data can be vary up to ±10%;
- 3、 he above parameters are all typical values ;

▼ **Light Distribution**

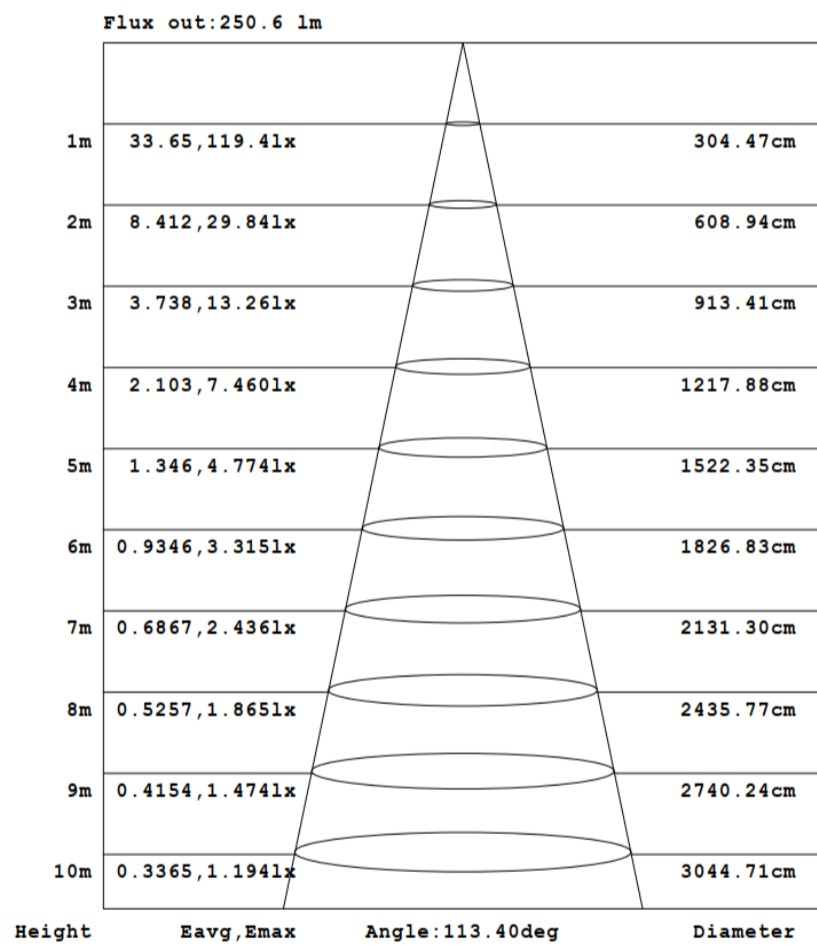

Effective average illuminance

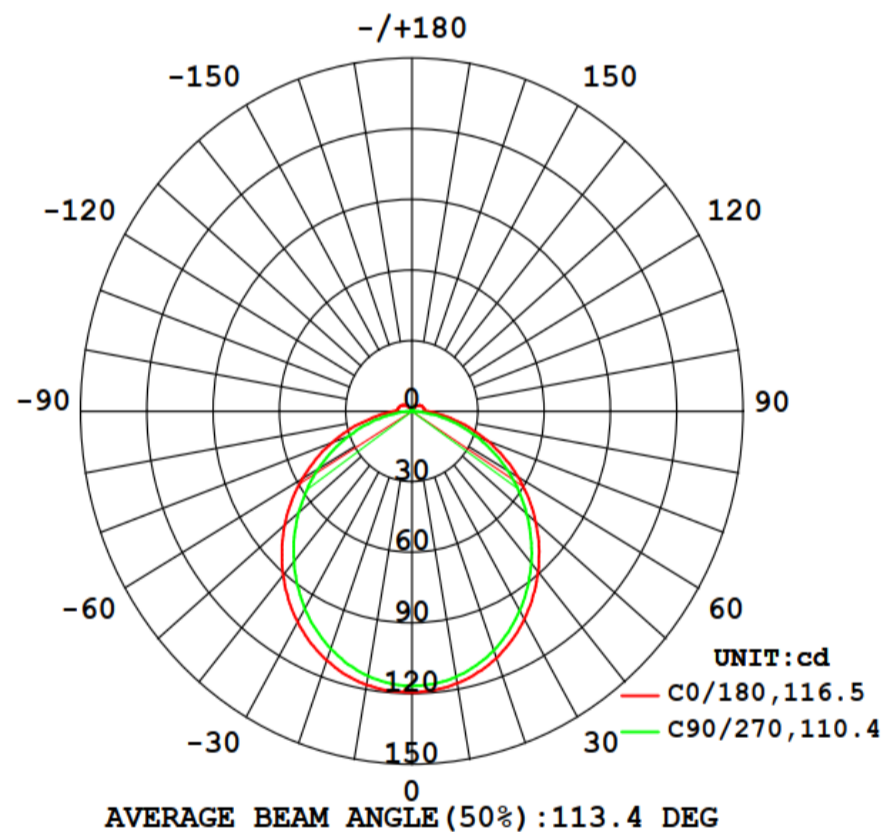

Light distribution

Note: The above data is based on the simultaneous lighting of three wicks, if there is need for the IES files of other colors, please download the specific file through the IES data bank.





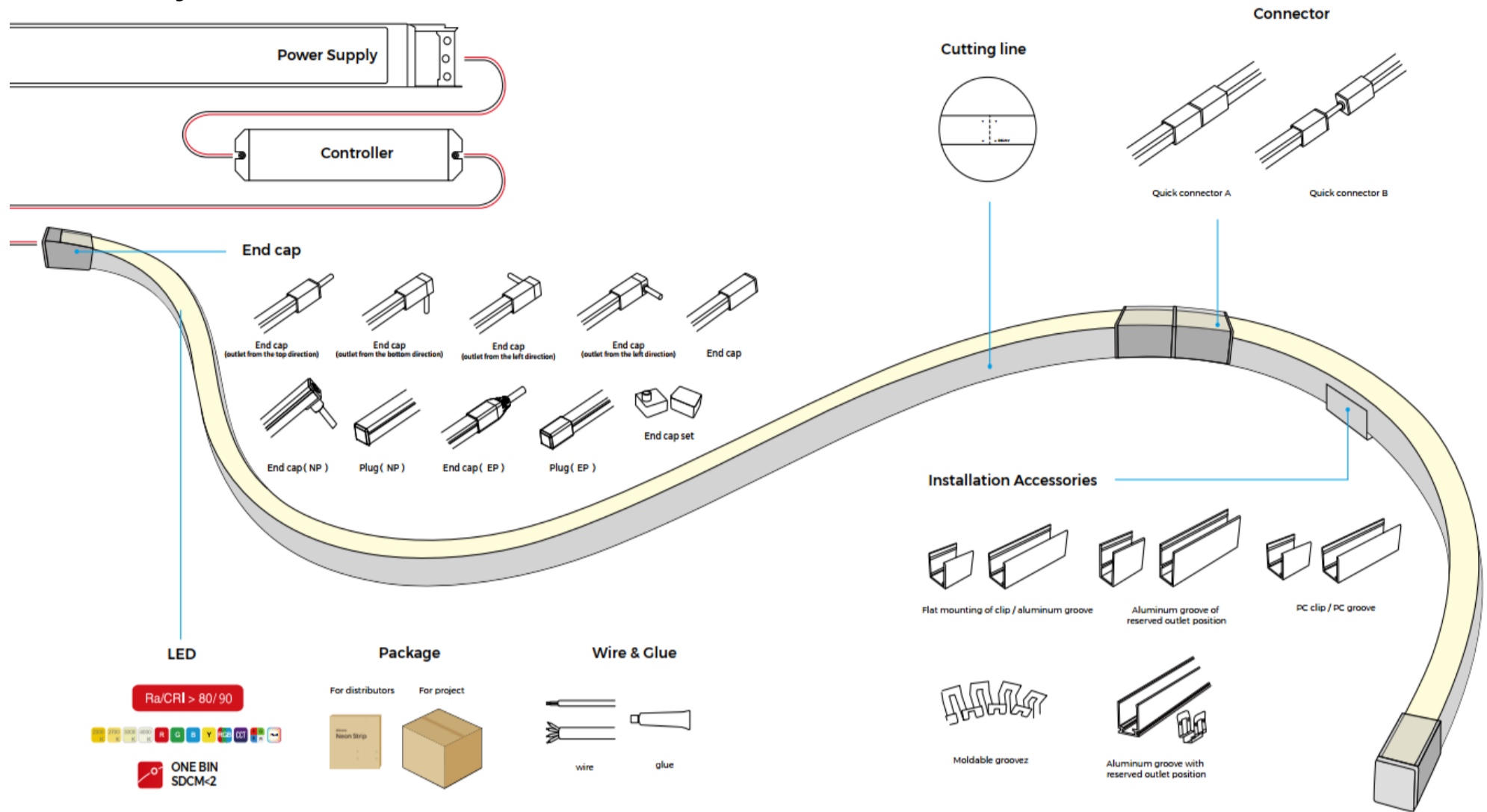





### ▼ Product System Solutions

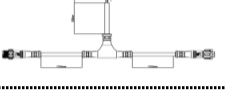
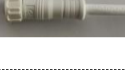

### ▼ Accessory information

Name	Description	Image	Sectional size	Ordering code	Product quantity/case (PCS)	Product quantity/case (kg)	Net weight per box (kg)	Gross weight (kg)	Gross weight (mm)	Remark
Aluminium carrier	Flat mounting aluminum groove			AS-NMT1312A-1000	30 PCS	0.1453	4.359	5.44	1100*112*50	Size : L1000*W15.4*H14.1mm, with screw
Aluminium clip	Flat mounting clip			AS-NMT1312A-25	450 PCS	0.0058	2.61	2.91	250*250*150	Size : L25*W15.4*H14.1mm, with screw
Aluminium carrier	Aluminum groove of reserved outlet position			AS-NMT1312A1-1000	24 PCS	0.1513	3.64	4.72	1290*112*50	Size : L1000*W15.4*H19.8mm, with screw
Aluminium clip	clip with reserved outlet position			AS-NMT1312A1-25	450 PCS	0.0061	2.745	3.045	250*250*150	Size : L25*W15.4*H19.8mm, with screw
Alumina carrier	Pre-installed aluminium groove			AS-NMT1312A2-1000	12	0.167	2	3.1	1290*112*50	Size : L1000*W16.6*H16.3mm with screws , 5 clips for 1 meter
PC carrier	Flat mounting PC groove			AS-NMT1312P-1000	30	0.066	1.98	3	1290*112*50	Size : L1000*W15.4*H14.6mm with screws
PC carrier	Flat mounting of PC clip			AS-NMT1312P-25	350	0.004	1.4	1.655	250*250*150	Size : L25*W15.4*H14.6mm with screws
Moldable carrier	Moldable groovez			AS-NMT1312M-500	66	0.046	4.55	6	500*290*290	Size : L500*W13.7*H13.5mm , with screw
End-Cap set	End cap set, including end cap and plug (outlet from the left direction)			AS-NMT1312GS0-EC	400	0.0035	1.4	1.7	250*250*150	/
End-Cap set	End cap set, including end cap and plug (outlet from the top direction)			AS-NMT1312GH0-EC	400	0.0035	1.4	1.7	250*250*150	/
End-Cap set	End cap set, including end cap and plug (outlet from the bottom direction)			AS-NMT1312GD0-EC	400	0.0035	1.4	1.7	250*250*150	/
Glue	Acid glue		/	AS-PG-0002	150	0.014	2.1	2.4	250*250*150	10ml/pcs







wire	3P PVCwire ( 0.5M )		/	AS-WS-0015	150	0.0154	2.31	2.61	250*250*150	Suitable for SPI strip Self processing use\IP65
wire	3P PVCwire ( 2M )		/	AS-WS-0016	125	0.0616	7.7	8	250*250*150	
wire	4P PVC wire ( 0.5M )		/	AS-WS-0003	150	0.0194	2.91	3.21	250*250*150	Suitable for DMX512 strip
wire	4P PVC wire ( 2M )		/	AS-WS-0004	125	0.0776	9.7	10	250*250*150	Self processing use\IP65
wire	4P T型PVC线材			AS-FC-0004	20	0.075	1.5	1.95	250*250*150	Suitable for SPI&DMX512 lamp with cascade connection,IP67
Wire	4P female connector wire ( 0.25M )			AS-FC-0005	50	0.025	1.25	1.7	250*250*150	Suitable for SPI&DMX512 lamp with cascade connection,IP67
connector	2PIN IP68 Waterproof connector		/	AS-FC-0001	512	0.016	8.192	9.5	365*365*190	Suitable for T-type waterproof joint DC input
connector	3PIN IP68 Waterproof connector		/	AS-FC-0002	512	0.018	9.216	10.2	365*365*190	Suitable for SPI strip Self processing use
connector	4PIN IP68 Waterproof connector		/	AS-FC-0003	288	0.03	8.64	9.6	365*365*190	Suitable for DMX512 strip Self processing use





## ▼ Product Control System Solution

	Program-controlled digital controller	K-1000C	23-01-00-0048	Operating temperature: -30°C 85°C Power supply: direct current 5V-24V input Power consumption: 2W Data transferring port :1 (1*1024 pixel) Weight: 0.35 Kg	Product size: L159*W89*H24mm Storage type: SD card Capacity of storage card: 128MB-32GB Storage format: FAT or FAT32 Storage file: *.led	DMX/SPI suitable for all digital LED strips
	Program-controlled digital controller	K-4000C	23-01-00-0049	Operating temperature: -20°C 85°C Power supply: direct current 5V-24V input Power consumption: 5W Data transferring port : 4 (4*1024 pixel) Weight: 0.8 Kg	Product size: L180*W120*H30mm Storage type: SD card Capacity of storage card: 128MB-32GB Storage format: FAT or FAT32 Storage file: *.led	DMX/SPI suitable for all digital LED strips
	Program-controlled digital controller	K-8000C	23-01-00-0050	Operating temperature: -20°C 85°C Power supply: direct current 5V-24V input Power consumption: 5W Data transferring port :8 (8*1024 pixel) Weight: 0.8 Kg	Product size: L180*W120*H30mm Storage type: SD card Capacity of storage card: 128MB-32GB Storage format: FAT or FAT32 Storage file: *.led	DMX/SPI suitable for all digital LED strips
	Independent digital controller	M16+SPI-16S	23-01-00-0041	(Parameters of remote controller) Operating voltage: 3VDC (Battery CR2032) Operating frequency: 2.4GHz Changing mode: 16 Operating temperature: -30°C 55°C	(Dimming constant-voltage acceptor) Input voltage: 5-24VDC Output: SPI WIFI: 2.4GHz Operating temperature: -30°C 55°C Product size: L135*W30*H20(mm) Package size: L132*W198*H22 (mm)	Professional for SPI digital LED strip

## ▼ Wiring Diagram

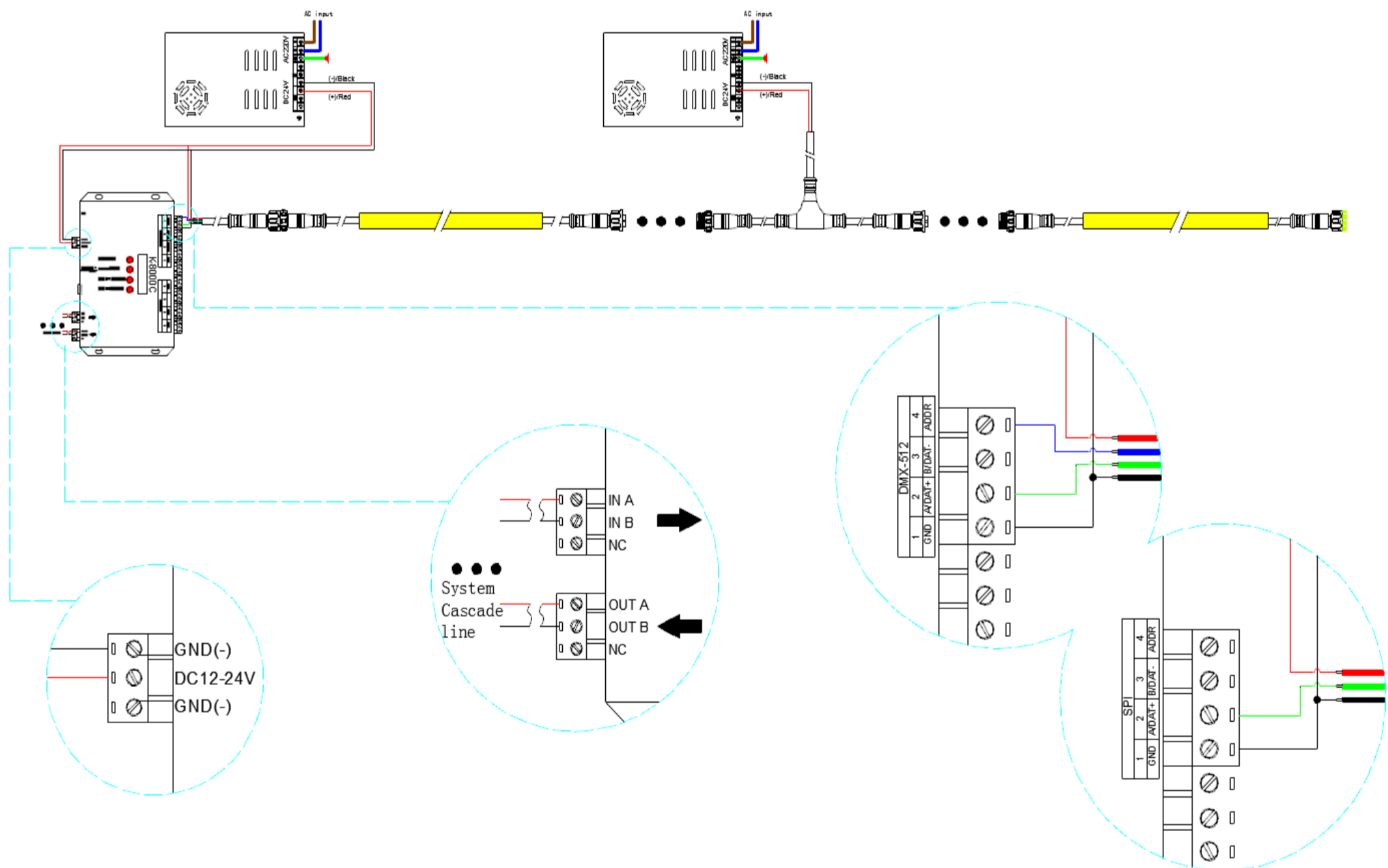

Model	Working Mode	Pixel Qty/m	Max Length Single Feed
SPI	UCS1903N	12	80m
DMX512	UCS512B3	12	10m



## ▼ Installation Guidance

### Installation of clip

1. Use screws to fix the clips or carriers on the mounting position

⚠ Clip: 3 clips can be used for 1m;

### Installation of carrier

1. When installing the LED strip, install it from both ends at the same time, installation from one direction is prohibited.

⚠ If the length of LED strip is over 2m, it is recommended to install by two persons.

> 2m

2. Use tool to disassemble carefully, and do not pull the LED strip directly.

⚠ If the length of LED strip is over 2m, it is recommended to disassemble by two persons.

> 2m



▼ **Packaging Solutions**

PN:NMT1312-Plus    PN:NMT1312-Plus  
Color:3000K(SPI)    Color:3000K(SPI)  
DC 24V                DC 24V



**NMT1312-Plus**

Voltage:	DC24V	Type:	Silicon neon strip
Power(Typ):	18W/m	Part NO:	XXXXXXXXXXXX
Power(Max):	20.2W/m	SO:	T7040T16
Color/CCT:	3000K(SPI)	Size:	5000x13x12mm
IP:	IP67	Date:	20170401

[www.colorsled.com](http://www.colorsled.com)

QTY:    PCS  
N.W:    KGS  
G.W:    KGS  
QC Date:20170503 **No.: 20**

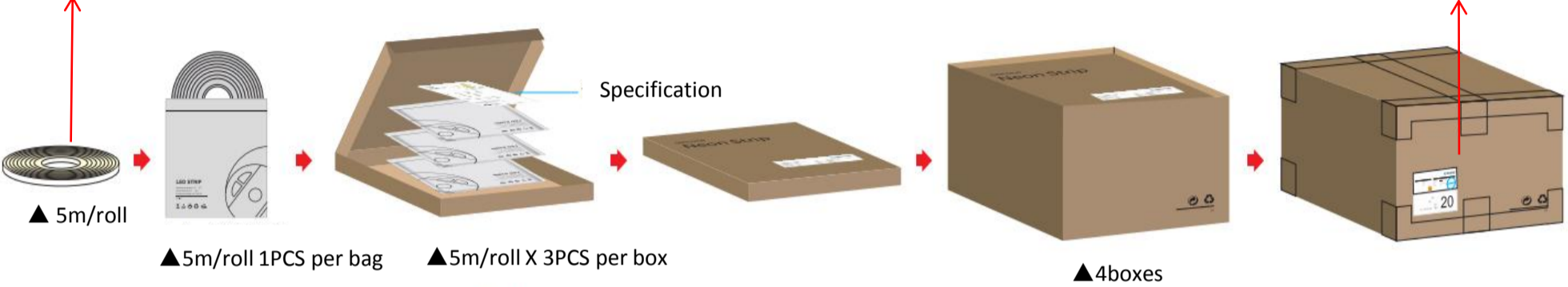

Model	Product size	Product Quantity/box	Product Quantity/case	Product net weight ( kg )	Net weight per box ( kg )	Gross weight ( kg )	Carton size ( M )
NMT1312-XXXXX24CDS025CC0500-Plus-EP	L5000*13*12mm	5M*3	60M	0.86	10.32	12	0.41*0.41*0.26M
NMT1312-XXXX24CDS025CC0500-Plus-EP							





## ▼ Ordering Code

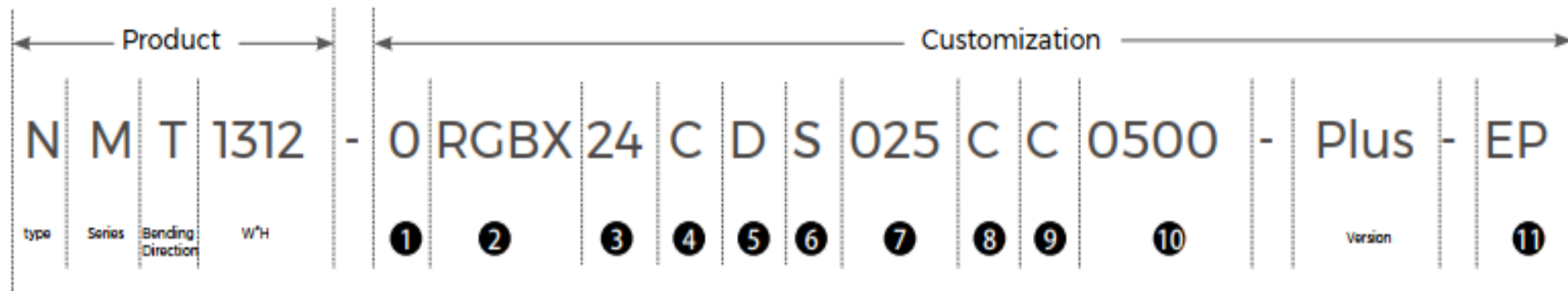

Simple steps, open to the outside world in an all-round way, customize personalized product

CRI	Code	1
RGB or colorful, no CRI	0	
CRI<80	7	
CRI>80	8	
CRI>90	9	

CCT/color	Code	2
2200-2400K	LW	
2600-2800K	SW	
2800-3200K	WW	
3200-3800K	PW	
3800-4200K	NW	
4800-5200K	DW	
Red	R	
Green	G	
Blue	B	
Yellow	Y	
Adjustable CCT	SWW	
RGB	RGB	
RGBW	RGBW	
RGBX(SPI)	RGBX	
RGBM(DMX)	RGBM	

Operating voltage	Code	3
DC12V	12	
DC24V	24	
DC48V	48	

Silk Printing	Code	4
COLORS	C	
Neutral	N	
Customized	S	

Entry cable	Code	5
One end	S	
Dual-ends	D	
No	X	

Wire Type	Code	6
PVC	N	
No wire	X	
Silicone wire	S	

Wire Length	Code	7
50CM	050	
No wire	000	

COLORS	Code	8
COLORS	C	
Package for distributors	B	

Label Type	Code	9
COLORS	C	
Customized	S	

Strip Length	Code	10
50m/reel	5000	
15m/reel	1500	
10m/reel	1000	
5m/reel	0500	

IP	Code	11
IP67	EP	
IP67	NP	

Ordering example : NMT1312-0RGBX24CDS025CC0500-Plus-EP

Cambered Neon Series(top bend), Width \* height: 13 \* 12mm, Pixel(SPI), DC24V, silk printing- Brand, Two end entry cable 25CM, brand package 5m/roll, plus version, IP67 end cap.



## ▼ Precautions

- Use a 24V DC isolated power supply to drive the neon lamp strip and the ripple wave of constant voltage source shall be less than 5%. It is not allowed to use RC voltage reduction or non-isolated power supply to drive the neon lamp strip.
- In actual applications, 20% of the power supply shall be kept (only 80% of the power is used) to guarantee that sufficient voltage is available to drive the product.
- Attention shall be paid to safe operation. After powering on, it is not allowed to touch the AC power supply to avoid an electric shock.
- Attention shall be paid to the positive and negative poles of the wires during installation and whether the power supply conforms to required voltages to avoid damages.
- Avoid scratching, distortion and irregular bending of the product during installation; otherwise it may cause irreparable damage to the product.
- Please do not bend the strip into an arc with a diameter less than 80mm to ensure the longevity and reliability, the bending diameter too small will damage the product itself.
- If the actual length of application exceeds the specified using length, it will lead to overload heating and uneven brightness.
- To keep the eyes from being harmed, try to avoid staring at the glowing side of the LED strip for a long time.
- Non-professionals are prohibited from installing, disassembling and repairing the product.
- Do not use any acid or alkaline adhesive to fix products (including not limited to glass cement, etc.)
- Product is not suitable for use in swimming pools and fountains.
- Please confirmed before usage as products of varied sizes show slight differences in their color under same color temperature due to their structural differences.
- When IP67 protective products are installed and applied, the waterproofing grade should be degraded after self-processing and cutting.
- Based on DMX512 project scheme, it can provide technical guidance for project scenario application in the early stage.

### Cutting method

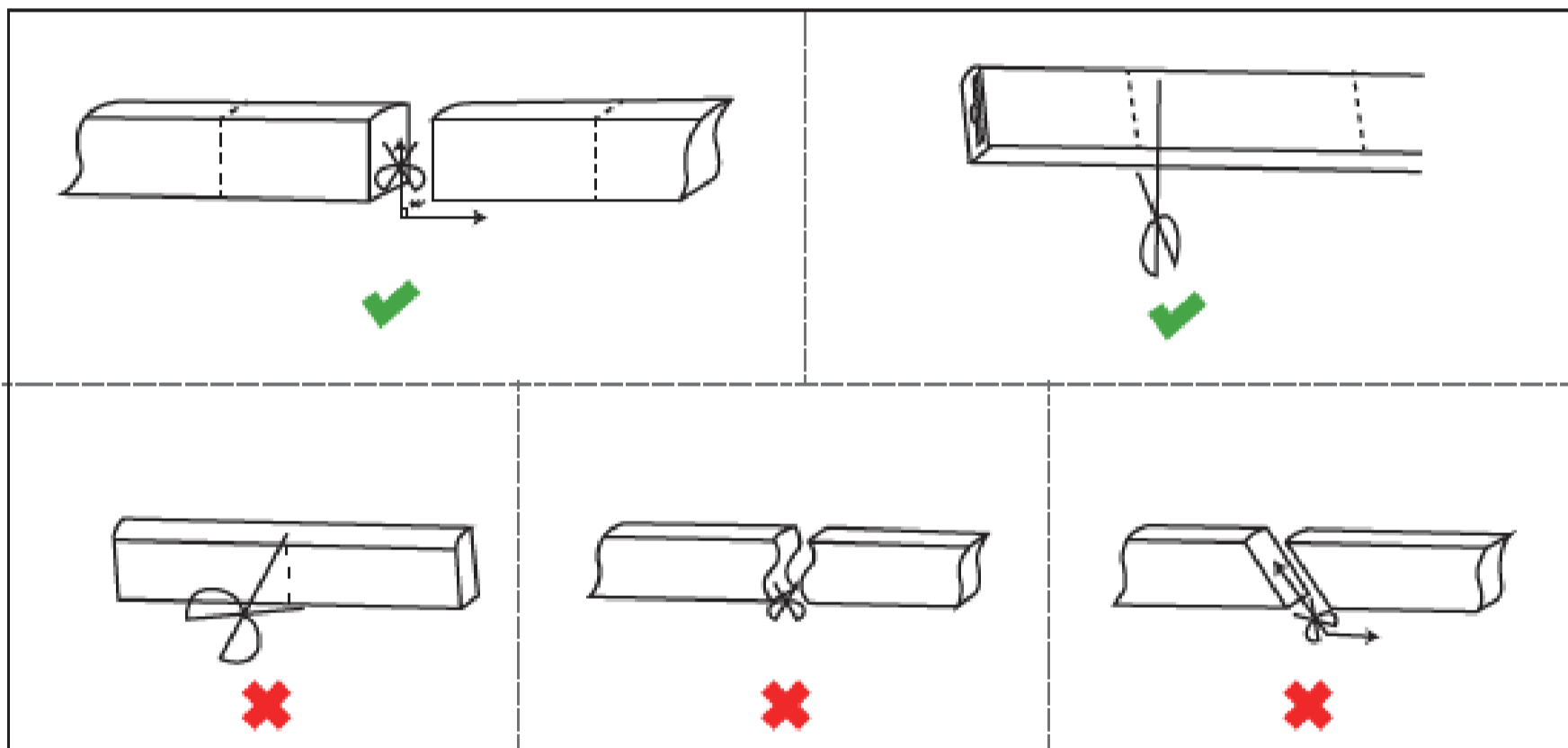

### It is forbidden to wrap objects less than 80mm

